

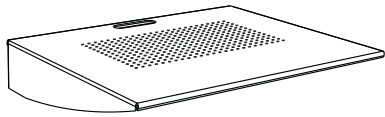

Classic LapTop shelf

In order to achieve a correct mounting of Classic LapTop shelf, you are advised to read and follow the instructions step by step. If there are incomprehensible steps, please let us know and we will get back to you.

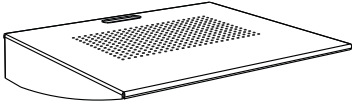

Part Check-List

| | |
|--|--|
| <p>①</p>  <p>x1</p> | <p>②</p>  <p>x2</p> <p>③</p>  (M6x10) <p>x2</p> |
|--|--|

① Place the sliding nuts② approximately 370 mm apart. Push them into the toolbar T-slot, then turn to make the spring face away from you.

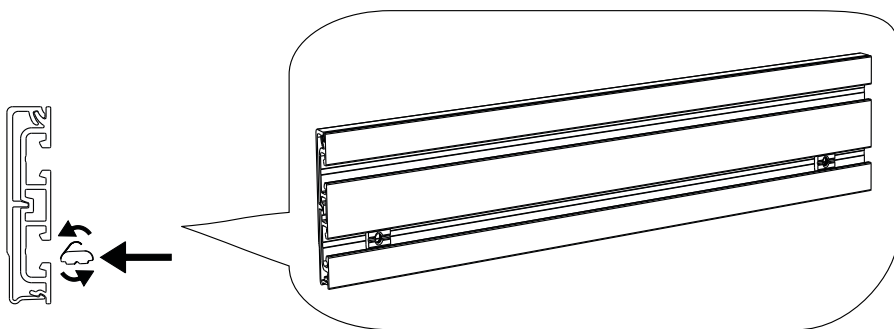

② Hook the shelf① to the upper toolbar T-slot. Leave hanging.

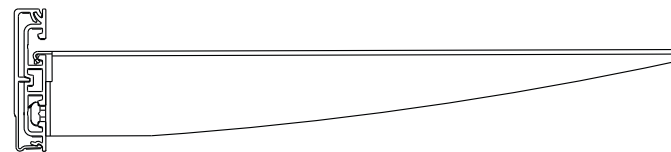
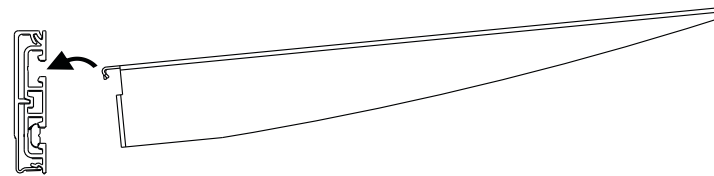

③ Align the screw holes of the sliding nuts② with each respective hole of the shelf①. Once aligned and hooked, mount the screws③.

